

The LS9405LED has been specifically engineered for use in fountains and other underwater features. When high output is required, it can be deployed in its full output, 2W configuration; If a dot of light is required, it can be set as low as 0.2W, (either by the factory or in the field). Alternatively, the luminaire can be dynamically dimmed via Lumascope d5 driver technology. Constructed in part from 316 Marine Grade Stainless Steel, this luminaire also comes with Lumascope proprietary **ElectroPolishPlus™** surface treatment as standard.

Performance

Static White & Colour	Lumen Output (lm)	Efficacy (lm/W)	Peak Intensity (cd)
● 3,000 K (80 CRI)	169	60	1,989
● 4,000 K (80 CRI)	184	66	2,066
● Blue (470nm)	-	-	-

Static white lumen output values are based on 2W luminaire with 14° lens.

Beam Angles	14°, 20°, 30°, 10° x 40°, Flood
--------------------	---------------------------------

Electrical

LED Power	1W, 2W	
Consumption	2.8W (maximum for 2W)	
Input Voltage	Low Voltage	24V DC (International Market) 12-15V AC, 12-24V DC (North American Market)

Control

Protocols	PWM (0-10V to PWM and DMX to PWM converters available)
------------------	--

Physical

Housing	316 Marine Grade Stainless Steel bezel with polymer housing
Installation	LS6107 Niche required
Water Temperature Rating	5°C to +40°C (41°F to 104°F)
Surface Temperature	≤65°C (≤149°F) HumanTouch™ Compliant

Certification & Compliance

IP Rating	IP68
IK Rating	IK10
Certifications	CE, ETL



Luminaire Dimensions

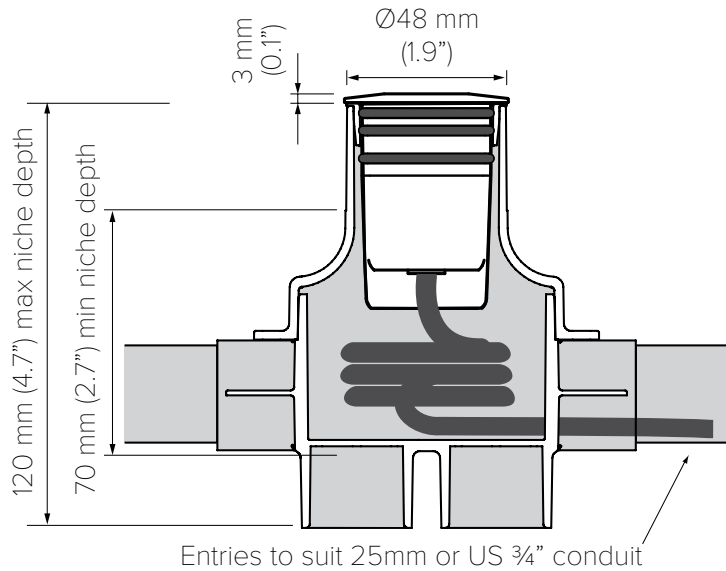

LS6107 - Niche
Order separately.

LS9405LED [] [] **SS** [] [] [] []

Power	Code
1W	1
2W	2

Static White & Colour	Code
3,000 K (80 CRI)	H6
4,000 K (80 CRI)	W4
Blue (470nm typical)	B4

Beam	Code
Narrow 14°	NR
Medium 20°	ME
Wide 30°	WD
Linear 10° x 40°	LN ⁽¹⁾
Flood	FL

(1) Linear with wall wash filter creates a linear horizontal beam.

Tilt	Code
Standard	U
Wall wash	W ⁽¹⁾

(1) Not applicable with FL beam.

Finish	Code
Stainless Steel	SS

Input Voltage (International)	Code
PWM Dimmable Driver, 24V DC	27 ⁽¹⁾

(1) Requires appropriate power supply

Cable Length	Code
8m	08
15m	15
20m	20
25m	25

Input Voltage (North America)	Code
PWM Dimmable Driver, 12-15V AC, 12-24V DC	23 ⁽¹⁾

(1) Requires appropriate power supply

Cable Length	Code
26ft	026
48ft	048
65ft	065
82ft	082

Photometric data is based on test results from a NIST traceable testing lab. IES data is available at www.lumascap.com
 Note: No depreciation factor is applied to the data shown.

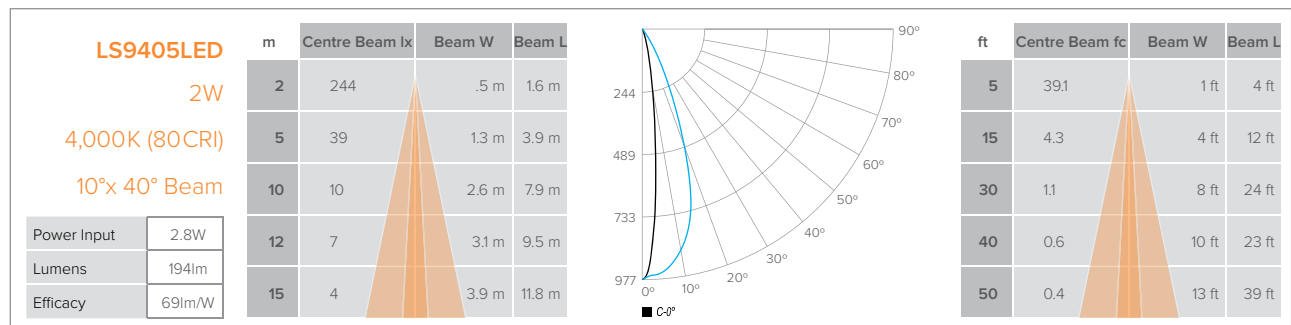
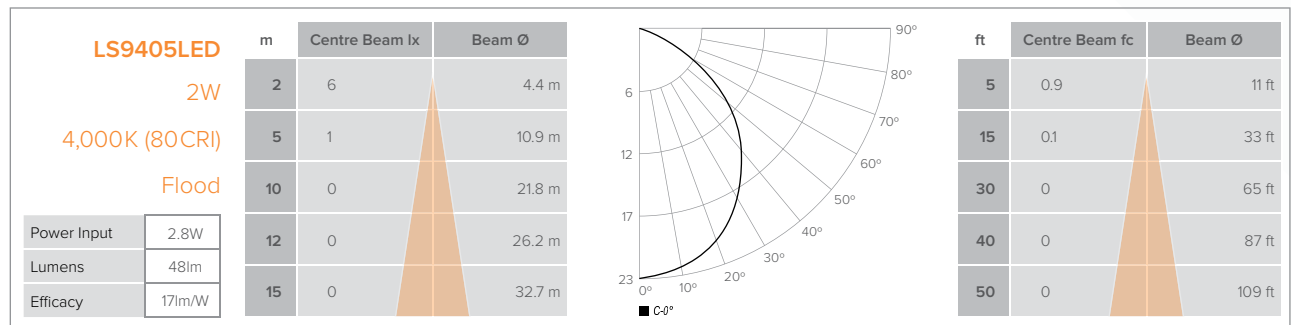
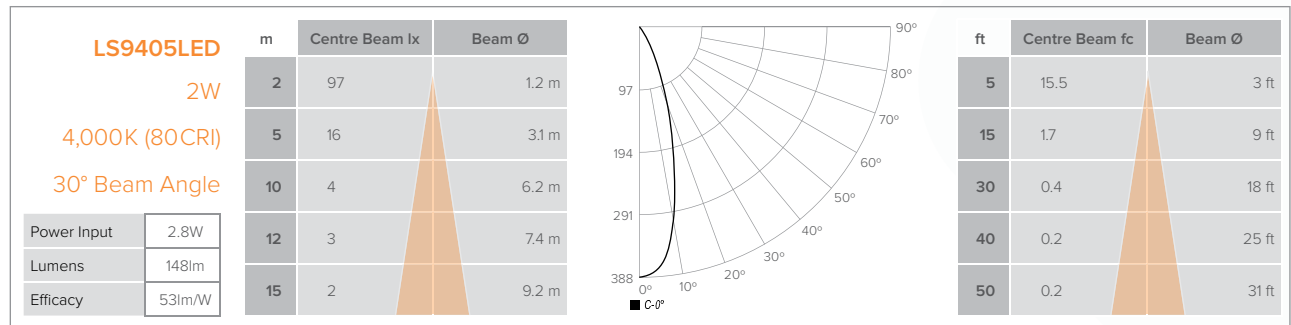
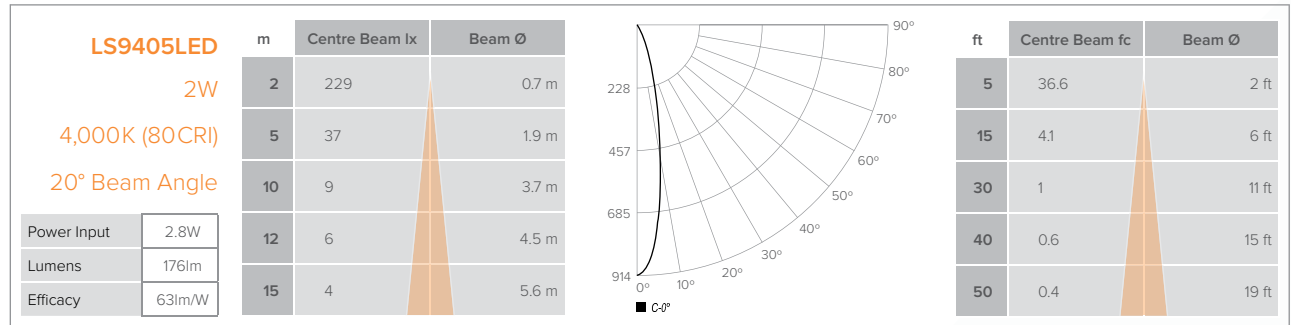
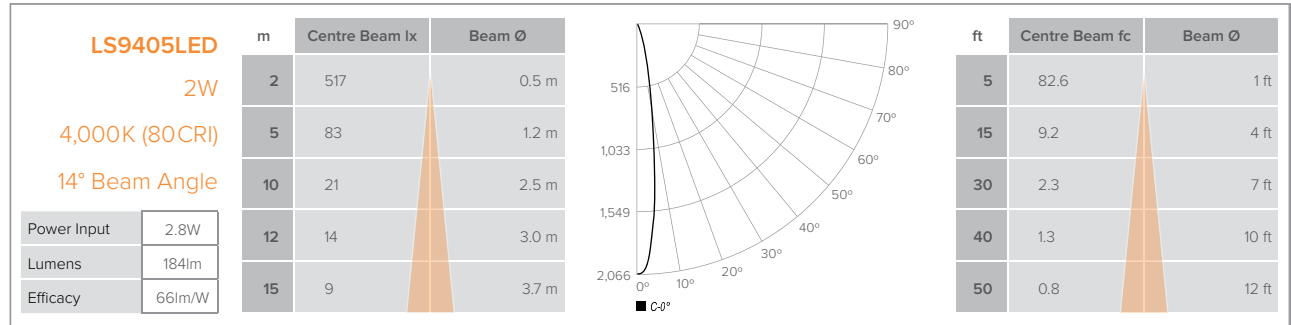

Wiring Diagram - Static Colour (DMX)

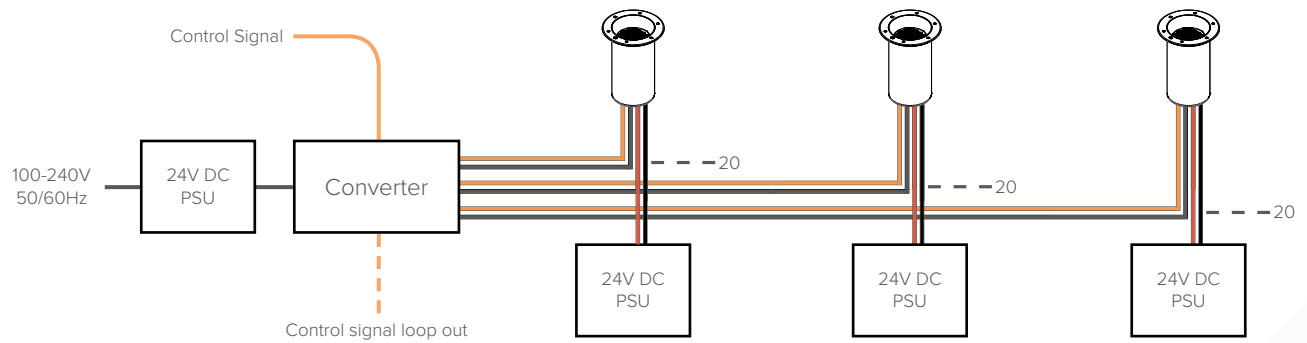

Control Protocols

DMX

For DMX control signal, use LS67100 DMX to PWM converter

Up to 20 luminaires per run under the following conditions:

- Up to three (3) individually addressed dimmable channels
- Up to 20 luminaires per dimmable channel
- Luminaires driven by integral LED drivers
- Luminaires powered through individual power supplies
- Refer to 'Maximum Circuit Load' table for circuit limitations
- Always observe local electrical codes for branch circuit current limitations
- Suitable for installation into swimming pools in Australia

Wiring Diagram - Static Colour (0-10V)

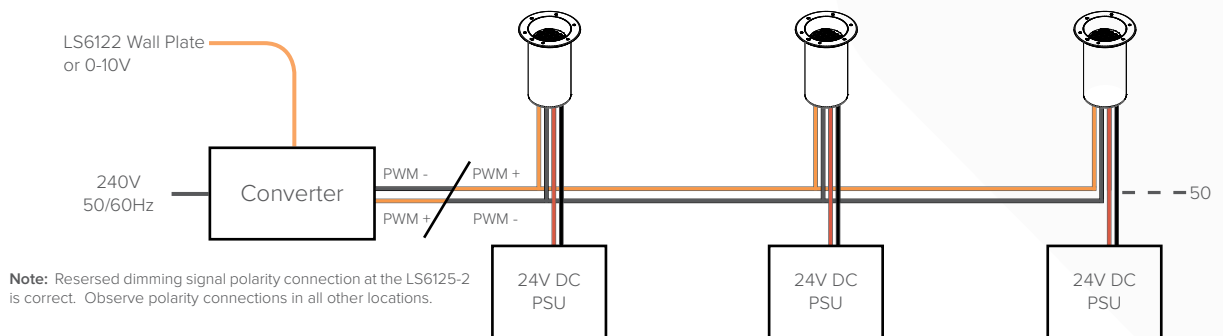

Note: Resersed dimming signal polarity connection at the LS6125-2 is correct. Observe polarity connections in all other locations.

Control Protocols

0-10V

For 0-10V control signal, use LS6125-2 0-10V to PWM converter

Up to 50 luminaires per run under the following conditions:

- Stand alone static colour dimming solution
- Up to 50 luminaires dimmed together
- Luminaires driven by integral LED drivers using LS6122 wall plate dimmer
- Luminaires powered through individual power supplies
- Refer to 'Maximum Circuit Load' table for circuit limitations
- Always observe local electrical codes for branch circuit current limitations
- Suitable for installation into swimming pools in Australia

Maximum Circuit Load

Compatibility with each driver is indicated by the value shown in the table, representing the maximum number of luminaires that may be powered from each driver based on a maximum cable run of 100m (328ft) and a trunk cable size of 3.3mm². Please note, this does not take into consideration voltage drop beyond a distance of 100m or ampacity limits of the branch circuit. For assistance, please consult factory.

LSLED-24V Power Supplies			
Input Voltage	100-240V, 50/60Hz		
Output Voltage	24V DC		
Wattage	40W	100W	150W
LS9405LED, 1W	20	45	75
LS9405LED, 2W	10	26	36

NOTE: The above diagrams are intended to show electrical pathways between luminaires and ancillary device. These diagrams are not intended to show type or colour of cord / wire, luminaire input voltage rating, wire gauge or approved use of the cord / wire supplied with luminaires.

Power Supply Specifications

DC Power Supplies

LSLED-24V100W240

24V DC Ripple Free Power Supply

Input	170-250V AC, 50/60Hz
Output	100W, 24V DC, 4.2A
Ambient Temperature Rating	-10°C to 50°C
Compliance	IEC61347-2-13, CE
IP Rating	IP66
Short Circuit Protection	Yes
Open Circuit Protection	Yes
Protection Class	Class II CE

LSLED-24V150W240

24V DC Ripple Free Power Supply

Input	90-305V AC, 50/60Hz
Output	150W, 24V DC, 6.3A
Ambient Temperature Rating	-10°C to 50°C
Compliance	IEC61347-2-13, CE
IP Rating	IP66
Short Circuit Protection	Yes
Open Circuit Protection	Yes
Protection Class	Class II CE

LSLED-24V40W240

Electronic DC Power Supply - wall mounted

Input	100-240V AC, 50/60Hz
Rating	40W / 1.67A
Output	24V
Ambient Temperature Rating	-25°C to 60°C (-13°F to 140°F)
Output Circuits	1
Approvals	CE, EN60950-1, EN61347-2-13
IP Rating	IP65/67
Dimensions	H 171mm W 62mm L 37mm (H 6.7" / W 2.4" / L 1.5")
Weight	0.7kg (1.6lb)

Control Related Equipment

LS6125-2

0-10V to PWM translator - wall mounted

Input	100-240V AC, 50/60Hz
Rating	20W / 0.83A
Output	24V
Ambient Temperature Rating	-10°C to 50°C
Open Circuits	1
Control Protocol	0-10V
Approvals	CE
IP Rating	IP65/67
Dimensions	H 204mm W 166mm L 91mm (H 8.0" / W 6.5" / L 3.6")
Weight	0.5kg (1.1lb)

LS67100

DMX to PWM translator

Input	24V DC
Rating	4 x 60W max
Output	4 x 2.5A max
Open Circuits	4
Approvals	CE, UL
IP Rating	IP65
Dimensions	H 286mm W 117mm L 82mm (H 11.25" / W 4.6" / L 3.2")
Weight	0.2kg (0.5lb)

Wiring Diagram - Static Colour (0-10V)

Please note: The use of a GFCI may be required. Consult local wiring rules.

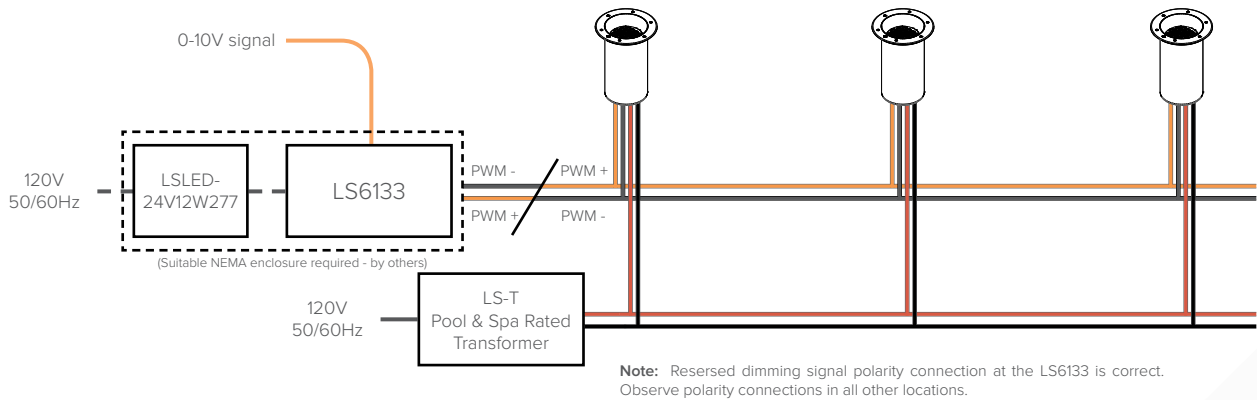

Control Protocols

0-10V For 0-10V control signal, use LS6133
0-10V to PWM converter

Wiring Diagram - Static Colour (0-10V / DMX)

Please note: The use of a GFCI may be required. Consult local wiring rules.

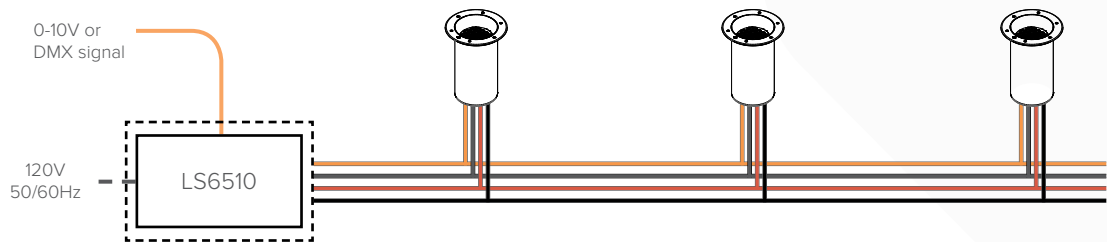

Control Protocols

0-10V For 0-10V control signal, use LS6510
0-10V to PWM converter

DMX For DMX control signal, use LS6510
converter

Maximum Circuit Load

Compatibility with each transformer or power supply is indicated by the value shown in the table, representing the maximum number of luminaires that may be powered from each transformer or power supply. Please note, this does not take into consideration voltage drop or ampacity limits of the branch circuit. In addition, dimming circuit total wire length must be kept under 328' (100m). For assistance, please consult factory.

	Pool, Spa & Fountain Power Supply			
	LS-T-100	LS-T-300	LS-T-500	LS6510
Input Voltage	120V, 60Hz			120V, 60Hz
Output Voltage	12/13/14V, 60Hz			24V DC
Wattage	100W	300W	500W	240W
LS9405LED, 1W	32	96	160	145
LS9405LED, 2W	16	48	80	73

NOTE: The above diagrams are intended to show electrical pathways between luminaires and ancillary device. These diagrams are not intended to show type or colour of cord / wire, luminaire input voltage rating, wire gauge or approved use of the cord / wire supplied with luminaires.

Transformer / Power Supply Specifications

Pool, Spa and Fountain Transformers

LS-T-100

Magnetic Transformer - wall mounted

Input	120V
Rating	100W
Output	12 / 13 / 14V
Output Circuits	1
Protection	Electrostatic shield, short circuit and over-voltage breaker
Approvals	UL, CUL
NEMA Rating	3R
Construction	Powder coated steel
Dimensions	H 9.06" W 5.06" D 4.59" (H 230mm / W 129mm / D 117mm)
Weight	12.5lb (5.7kg)

LS-T-300

Magnetic Transformer - wall mounted

Input	120V
Rating	300W
Output	12 / 13 / 14V
Output Circuits	1
Protection	Electrostatic shield, short circuit and over-voltage breaker
Approvals	UL, CUL
NEMA Rating	3R
Construction	Powder coated steel
Dimensions	H 9.06" W 5.06" D 4.59" (H 230mm / W 129mm / D 117mm)
Weight	13lb (5.9kg)

LS-T-500

Magnetic Transformer - wall mounted

Input	120V
Rating	500W
Output	12 / 13 / 14V
Output Circuits	1
Protection	Electrostatic shield, short circuit and over-voltage breaker
Approvals	UL, CUL
NEMA Rating	3R
Construction	Powder coated steel
Dimensions	H 9.06" W 5.06" D 4.59" (H 230mm / W 129mm / D 117mm)
Weight	14lb (6.4kg)

Control Related Equipment

LS6133

0-10V to PWM translator - NEMA enclosure required (by others)

Input	24V DC
Rating	96W max
Output	4A max
Output Circuits	1
Approvals	UL, CUL Recognised, Class 2
IP Rating	IP66
Dimensions	H 5.2" W 1.3" D 1" (H 132mm / W 33mm / D 25mm)
Weight	0.2lb (0.1kg)

LSLED-24V12W277

Electronic DC Power Supply - NEMA enclosure required (by others)

Input	120-277V, 50/60Hz
Rating	12W / 0.5A
Output	24V DC
Output Circuits	1
Approvals	UL, CUL Recognized, Class 2
IP Rating	IP66
Location	Wet location
Dimensions	H 3.35" W 1.42" D 0.91" (H 85mm / W 36mm / D 23mm)
Weight	0.282lb (0.1kg)

Control Related Equipment Cont...

LS6510

Power Unit for Pool, Spa & Fountain Luminaires

Input	120V
Rating	240W
Output	24 or 30V DC
Output Circuits	1
Approvals	UL 379, CAN/CSA C22.2 No. 218.1, 218.2, CE
IP Rating	IP65, suitable for wet locations
Dimensions	H 5.3" W 13.4" D 9.3" (H 134mm / W 341mm / D 236mm)
Weight	13.2lb (6.0kg)